

Brushless Direct Drive Torque Motors Megaflux MFH170i Series

Large-Bore Hollow Shaft Housed Torque Motor with Integrated Digital Servo Drive and Optical Encoder

Allied Motion's Megaflux MFH170i series of 170 mm (6.7 in) diameter housed brushless torque motors consists of a high performance brushless DC torque motor, a digital servo drive, and an optical encoder, all integrated into a rugged machined aluminum housing with robust bearings.

The MFH170i series features a 63.5 mm (2.5 in) large-bore through shaft, and is characterized by a very high torque-to-inertia ratio. There are three stack lengths in the series with peak torque ranging from 10.6 up to 16.9 Nm (1500 up to 2400 oz-in). The standard winding voltage is 48 V.

This product was specifically designed for direct drive, high resolution positioning applications in semiconductor wafer handler robots, turret scanners, and similar precision manufacturing equipment and instrumentation.

The series is offered as standard with an integrated optical sine-cosine encoder, CANopen / Modbus RTU communication ports, and DB-style connectors.

Options & Accessories

- Connectorized mating cables
- Programmable-interpolation encoder with multiplier from 2^2 up to 2^{14}

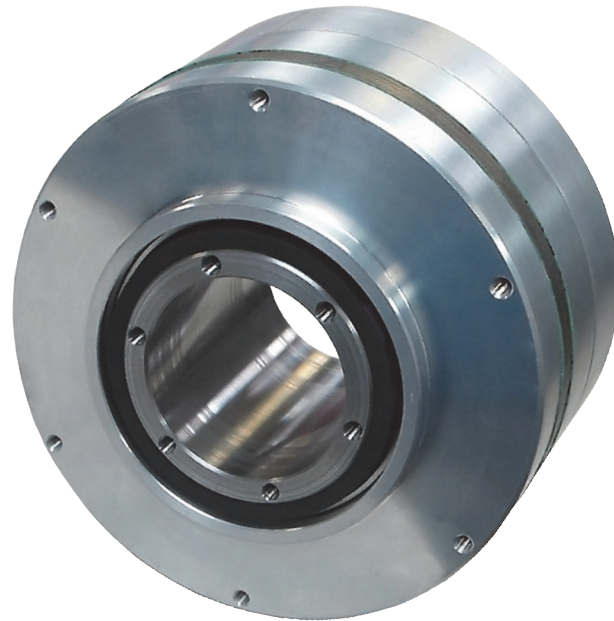

Features & Benefits

- $\varnothing 170$ mm (6.7 in) OD; $\varnothing 63.5$ mm (2.5 in) ID large-bore hollow-shaft
- Peak torque up to 16.9 Nm (2400 oz-in) and rated speed to 1000 RPM
- Integrated servo drive with CANopen and Modbus
- Integrated optical incremental encoder
- Large-bore 63.5 mm (2.5 in) through-shaft allowing passage of air, fluid, and/or vacuum lines, optical beams, and/or electrical lines
- Sinusoidal SVM commutation for efficient, smooth operation
- High torque-to-inertia ratio and motor constant for responsive and efficient operation
- High performance integrated digital servo drive for compactness and reduced system wiring complexity
- 3600 line integral sine encoder, 14400 counts/rev effective resolution
- Position control via CANopen, Modbus or .NET framework
- RoHS compliant

Megaflux 170i – Specifications

Model	MFH-170010AIZ	MFH-170025AIZ	MFH-170050AIZ	
DC Input Voltage	48 VDC			
Rated Torque (Nm)	Continuous Stall	2.66	6	10
	@ Rated Speed	2.17	4.8	8.5
	Peak ⁽¹⁾	10.6	11.9	16.9
Rated Speed (RPM)	1000	1000	750	
No-load Speed (RPM)	1600	1400	1000	
Rated Power ⁽²⁾ (W)	227	502	670	
DC Input Current (ADC)	5.6	11.7	15.5	
Thermal Resistance (°C/W)	1.3	0.9	0.8	
Motor Rotor Inertia (E-3 kg-m ²)	3.05	4.60	7.05	
Weight (kg)	5	6.8	10	
Amplifier Type	PWM (20 kHz nominal) 4-quadrant control with sinusoidal SVM commutation			
Current (Torque) Loop	DQ PI, 100 µs update time			
Velocity Loop	PID / PDF 200 µs update time			
Position Loop	PFF, 500 µs update time			
Command Input	<ul style="list-style-type: none"> • Primary analog input: ±10VDC, 10kΩ, 12-bit resolution • Secondary analog input: ±10VDC, 500Ω, 12-bit resolution (or 4 - 20 mA) 			
Setup Port	RS-232, 460 kBd for setup and tuning using INControl software on a PC			
Bu	Isolated CANopen (+10 V to +32 V, 50 mA) or Modbus RTU (two-wire, half-duplex over RS-485)			
Digital I/O	<ul style="list-style-type: none"> • 6 inputs: Current-sourcing, +3 to +60 V (high), 0 to 0.5 V (low) at 3 mA nominal draw • 3 outputs: Current-sinking, open collector, +60 V max., 100 mA sink 			
Analog Output	0 - 5 V, 12-bit resolution			
Encoder	<ul style="list-style-type: none"> • Type: Integral optical sine/cosine • Resolution: 3600 lines, 14400 counts/rev after quadrature interpolation (encoder signals not available for external use) • Disk accuracy: 1.25 arc seconds 			
Protection Features	<ul style="list-style-type: none"> • DC supply bus over- or under-voltage • Short-circuit and reverse polarity • I²T current foldback • Drive over-temperature • Motor over-temperature • IP50 			
Ambient Temperature	Operating	-20 to 40 °C		
	Storage	-40 to 100 °C		

(1) Maximum of 4 sec.

(2) With motor mounted to aluminum plate 200 x 200 x 10 mm at 23 °C (derate motor power above 23 °C ambient temperature)

Megaflux 170i – Performance

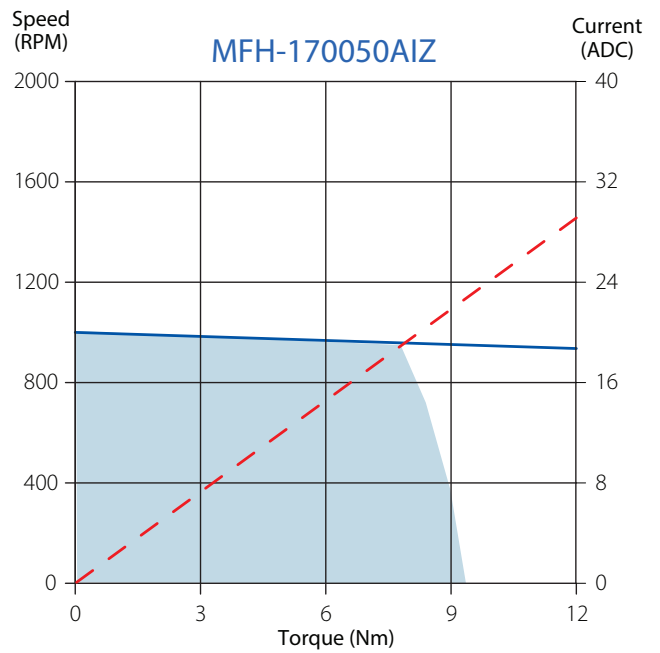
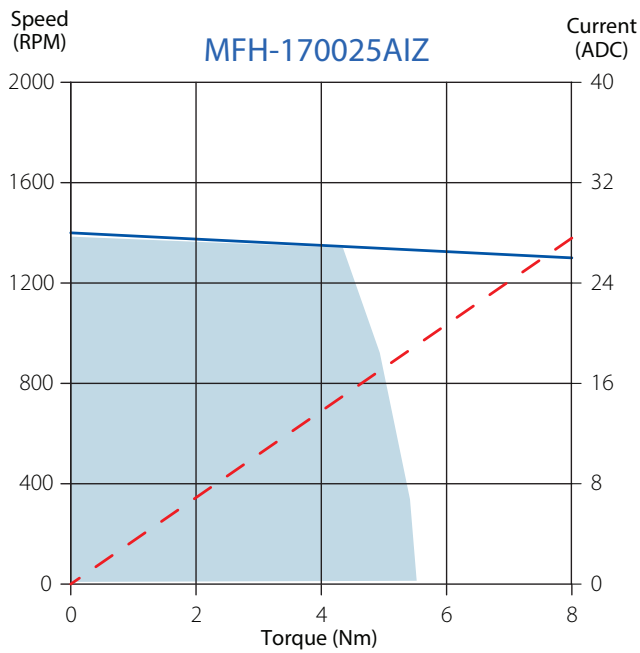
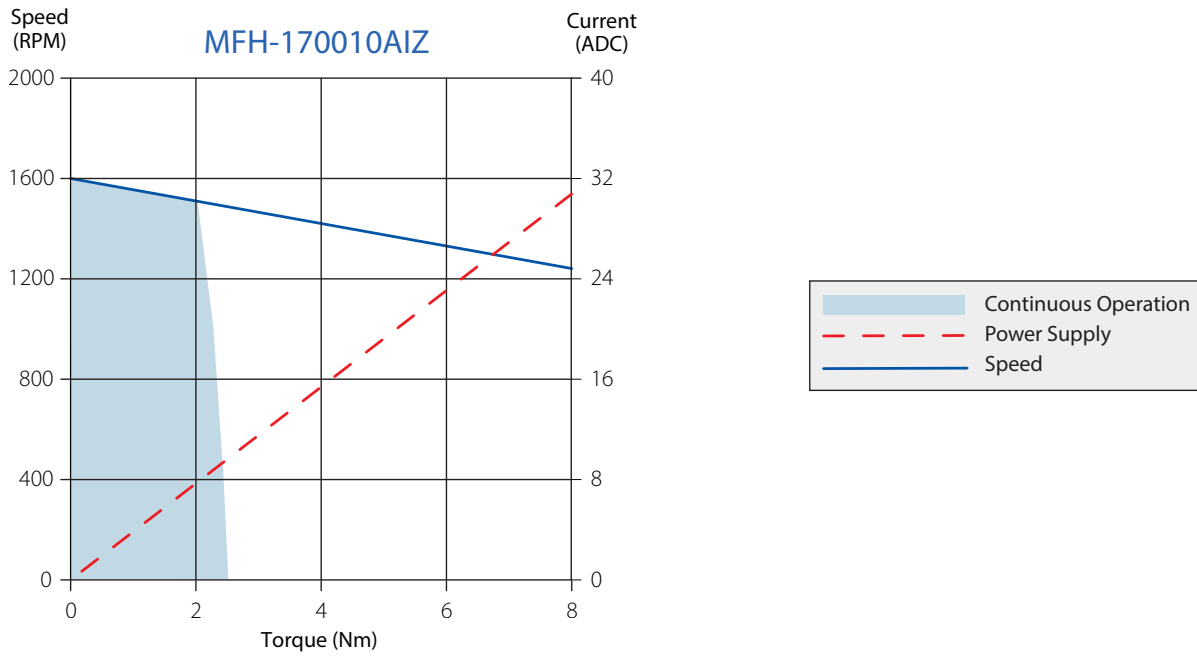

Megaflux 170i — mm (in)

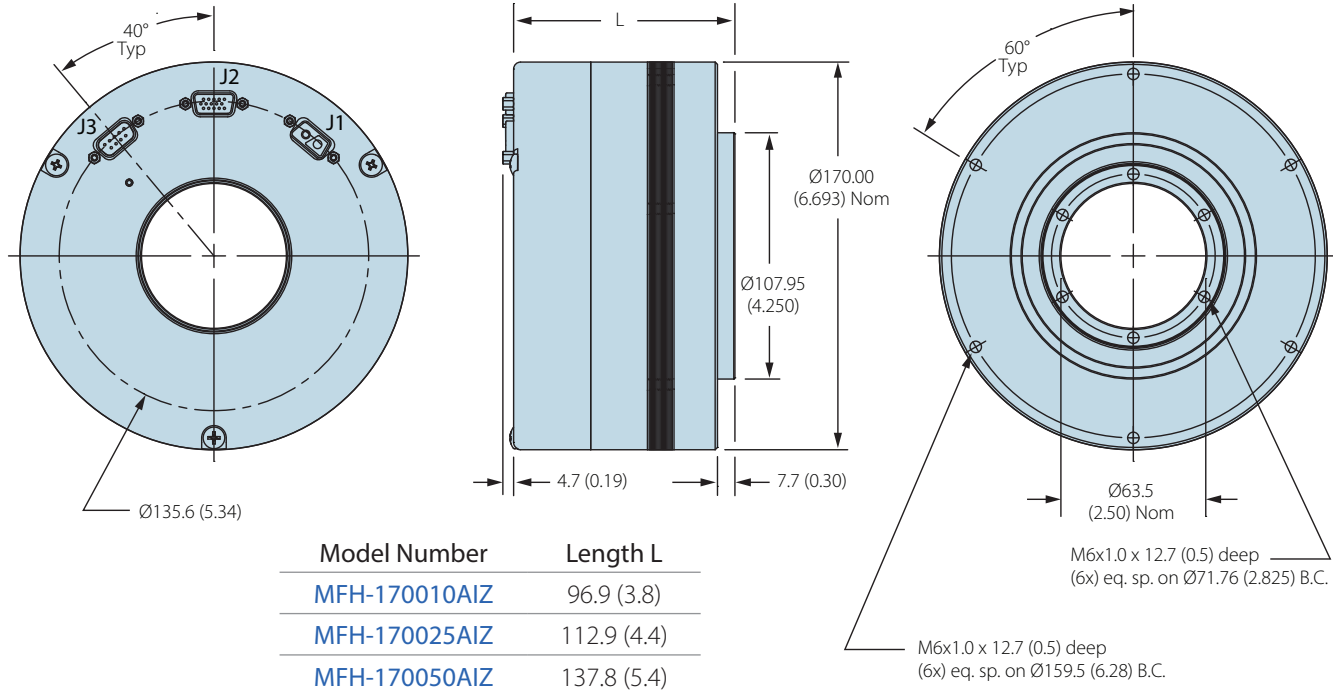

Megaflux 170i Electrical Connections

Motor Power (J1)

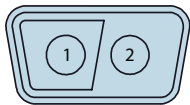

Pin	Function
1	DC Power (-)
2	DC Power (+)

Mate: Konmek PS400N-2WK2FTB0
Sealed Mate: Konmek PS400N-2WK2FTB0 w/HW1-1 shroud

User I/O (J2)

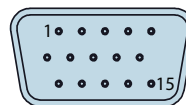

Pin	Function
1	Input 1
2	Input 2
3	Input 3
4	Input 4
5	Analog Input 1 (+)
6	Input 5
7	Input 6
8	RS232 Rx
9	Output 1
10	Analog Input 1 (-)
11	Output 2
12	Output 3
13	RS232 Tx
14	Common
15	Analog Input 2 (+)

Mate: Konmek HS0-15FTB0
Sealed Mate: Konmek HS0-15FTB0 w/HW1-1 shroud

CANopen or Modbus (J3)

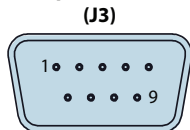

Pin	Function
1	Modbus/Analog Out Common
2	CANL
3	CAN COM
4	Modbus Tx / Rx (-)
5	—
6	Analog Out
7	CANH
8	Modbus Tx / Rx (+)
9	CANV+

Mate: Konmek DS0-09FTB0
Sealed Mate: Konmek DS0-09FTB0 w/HW1-1 shroud

Megaflux 170i Cable Accessories

	Description	Part Number
I/O Cables	1 m, 15 pin D-Sub to 6.4 mm strip	AC-CB-822002
	3 m, 15 pin D-Sub to 6.4 mm strip	AC-CB-822003
CAN/ Modbus Cables	1 m, 9 pin D-Sub to 6.4 mm strip	AC-CB-822004
	3 m, 9 pin D-Sub to 6.4 mm strip	AC-CB-822005
Power Cables	1 m, D-Sub 2-wire, 10 gauge, to flying leads	AC-CB-822006
	3 m, D-Sub 2-wire, 10 gauge, to flying leads	AC-CB-822007
	1 m, D-Sub 2-wire, 14 gauge, to flying leads	AC-CB-822008
	3 m, D-Sub 2-wire, 14 gauge, to flying leads	AC-CB-822009

Documents & Software

Documentation and most software are available for download from the Allied Motion website (www.alliedmotion.com)

34-2100	Hardware Manual: Wiring and Installation (PDF)
34-2200	Software Manual: IN Control User Guide (PDF)
34-2202	Software Manual: Parameters and Control Structure (PDF) + (Attachment A) Sortable Parameters and Variables List (Excel file)
34-2300	Communications Manual - CANopen
34-2301	Communications Manual - Modbus
AM_Drive CANopen MODBUS params.xls	CANopen and MODBUS parameter/variable mapping spreadsheet
AM_Drive.eds	Allied Motion EDS file for CANopen drives
—	ALLNET .NET Framework software

Custom & Specific-Purpose Products & Sub-Assemblies

Allied Motion offers a very wide selection of standard motion control solutions to satisfy the requirements found in the commercial, industrial and aerospace and defense markets. And, we are adding new products every year to meet new demands we find in those markets.

However, a recognized strength of Allied Motion is our willingness and ability to develop custom motion control products and systems to meet the specific needs of customers. Please contact us to discuss your specialized application requirements.

Allied Motion Solution Centers

Allied Motion maintains Solution Centers in three geographically strategic locations to assist our customers with all aspects of their product selection and buying decisions. These facilities assure local support no matter your location around the globe.

Each Solution Center's experienced application engineering and customer service team provide:

- Application analysis assistance
- Detailed product information and documentation
- Standard product selection
- Product customization and options guidance
- Specification development assistance for custom-design products
- Price quotations
- Ordering, order status and shipment information
- Logistics assistance

For assistance with your project, contact us at one of our continental Allied Motion Solution Centers listed below.

Allied Motion also has a global network of factory trained selling partners to serve you. Visit our website for contact information for the Allied Motion Sales Partner nearest you.



High-Performance Specialty Motors & Application-Specific Motion Systems

Aerospace & Defense
Automation
Commercial-Consumer
Industrial
Medical
Pumps
Robotics
Vehicles

www.alliedmotion.com

North America

United States, Canada, Mexico:

Allied Motion Technologies NASC

495 Commerce Drive
Amherst, NY 14228 USA

+1 (716) 242-7535

inquiry@alliedmotion.com

Europe

UK, Ireland, continental Europe,
Eastern Europe, Scandinavia, Israel:

Allied Motion Technologies EUSC

Ekbacksvägen 26, PO Box 11198
S-161 11 Bromma, Sweden

+46 (8) 546 111 00

inquiry@alliedmotion.com

Asia

China, Taiwan, Japan, S. Korea, and
other Far East Countries:

Allied Motion Technologies ASC

58 Leshan Road
Xinbei District, Changzhou 213022
China

+852 2607 4038 +86 519 85113625

inquiry@alliedmotion.com